

Three Dimensional Design BA (Hons)

Application Process 2022/23



Northumbria
University
NEWCASTLE



How do I make an application?

Your application to study for an undergraduate degree at Northumbria University is in two parts:

- **UCAS* Application form**
- **Digital Portfolio & Portfolio Statement**
(Note - Digital portfolio is 15 images and the Statement is 300 words)

****EU and International students can apply direct***

When you apply, you will receive an email from Northumbria University confirming receipt of your application. If you are made an initial offer, you will be given instructions on uploading your Digital Portfolio. Read the instructions carefully because they will give you important information on deadlines, maximum file sizes, upload instructions etc.

The following slides will give you guidance on compiling your Digital Portfolio & Portfolio Statement. It also includes course specific details on uploading your files, what to include in the Digital Portfolio & Portfolio Statement etc.

How do I make an application?

The key milestones in the application process are as follows:

- 1 - Apply through UCAS
- 2 - Receive an initial offer
- 3 - On receiving an initial offer, you will be given instructions on uploading your Digital Portfolio & Portfolio Statement
- 4 - Northumbria University specialist staff assess your UCAS application, Digital Portfolio and Portfolio Statement
- 5 - The outcome will be communicated through UCAS and will be one of the following:

- **Conditional Offer**
- **Unconditional Offer**
- **Alternative course offer**

We have illustrated the Application process as an Application Journey on the following page.



What is the application Journey?

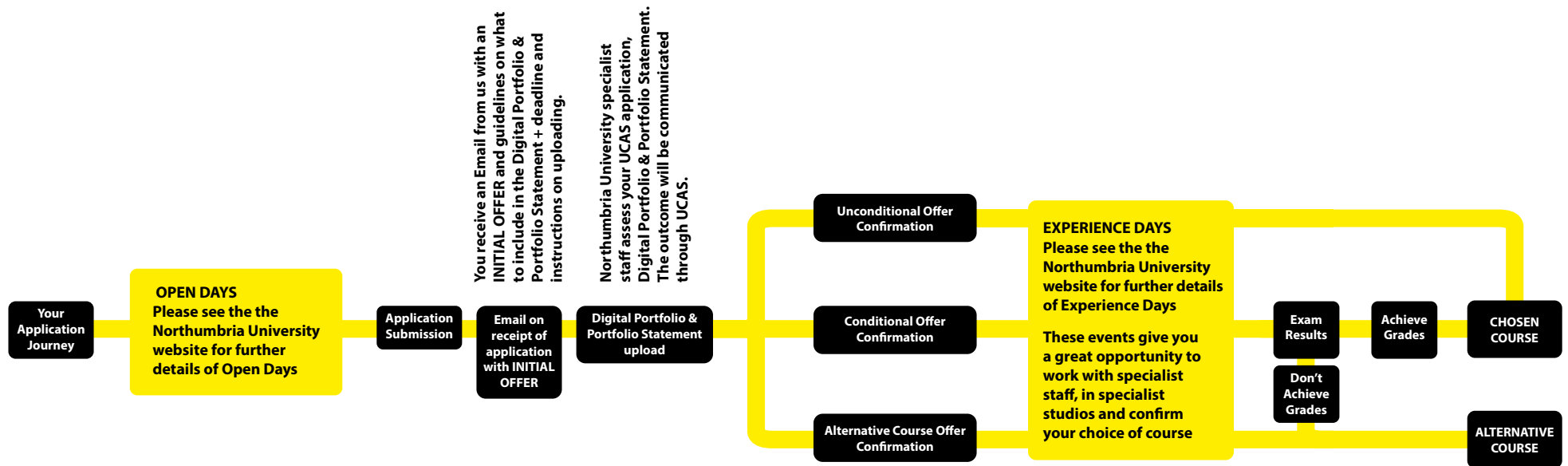

What should be in my Digital Portfolio?

For Year 1 entry, your Digital Portfolio should consist of 15 pages, showing the following:

Page 1 — A 300 word supporting Portfolio Statement. This Portfolio Statement is different to the personal statement in your UCAS application.

We are interested in what inspires you, who inspires you and how you communicate that enthusiasm through your statement and your work. Which designers and artists are you looking at and referencing? Who, or what, has inspired you to choose the specialist subject you are applying for?

We are interested in how you talk about your work and communicate the ideas behind the projects and the elements of the projects you consider to be the most successful.

You should use the Portfolio Statement and your UCAS personal statement to talk about these areas.



**Northumbria
University**
NEWCASTLE

What should be in my Digital Portfolio? (cont)

Your Digital Portfolio should consist of 15 pages, showing the following:

Pages 2 to 12 — Show examples of your college/school work. It is important that these pages demonstrate both your ability to generate and develop concepts, alongside practical skills and how you explore and use different media and materials.

As a guide, you could include three or four pieces of work in this section. Where possible, you need to show initial concepts, development work and final pieces. These can be evidenced in a variety of ways, including scans/photographs of your sketch work/prints/paintings, images taken from CAD packages, photographs of your models/prototypes and photographs of your final 3D pieces. We are particularly

interested in seeing 'hands-on', materially-engaged approaches to designing and making. The examples need not be limited to work of a three-dimensional nature, however—if you have explored other media, such as printing, life drawing, photography or painting, please feel free to include these too.

Note - You can arrange the images in whichever way you feel tells the story of a project in the most effective way. You could have one image on a slide, or several small images could be grouped together in one slide.



What should be in my Digital Portfolio? (cont)

Your Digital Portfolio should consist of 15 pages, showing the following:

Pages 13 to 15 — Show us some of your personal work. We want students who are excited by the subject they choose and are engaged in the world around them. We want to see some independently generated work, i.e. self directed work which you have produced outside your current school/college/ other course curriculum which demonstrates your own personal interests.

These pages should be made up of your own work, we don't want to see lots of secondary source material.

(Note - For Year 2 or 3 entry, UK and International students may need to provide an enhanced portfolio. Details will be given on receipt of your application)



**Northumbria
University**
NEWCASTLE

What format should my Digital Portfolio be in?

The Digital Portfolio should be submitted as an A4 or A3, 15 page Adobe Acrobat PDF. The maximum file size for this PDF is 30 Megabytes (MB).

How do I upload my Digital Portfolio?

The email containing your Initial Offer will also have a link to the Digital Portfolio upload area. Follow the instructions to upload the Portfolio.

BA (Hons) Three Dimensional Design Portfolio Examples

The following pages give some Portfolio Examples.



**Northumbria
University**
NEWCASTLE

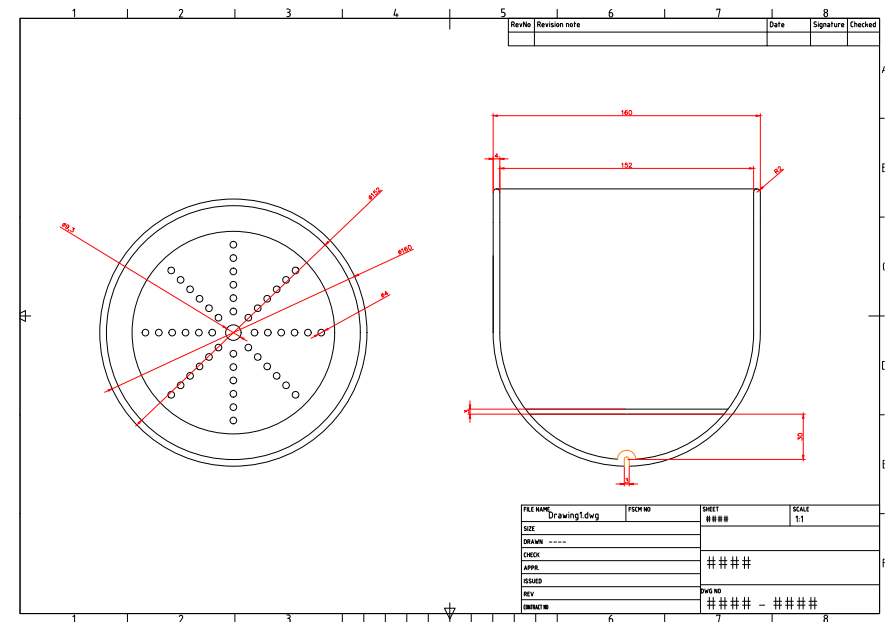
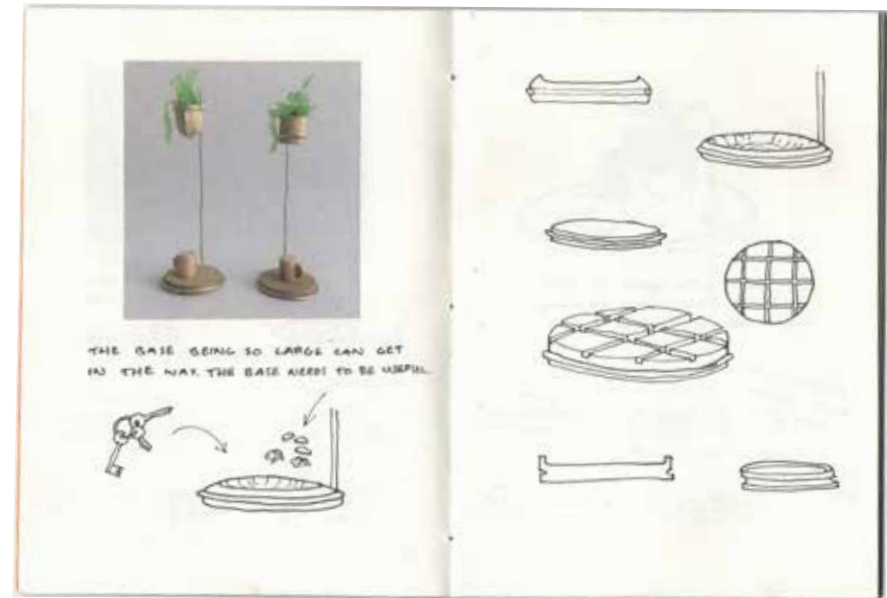
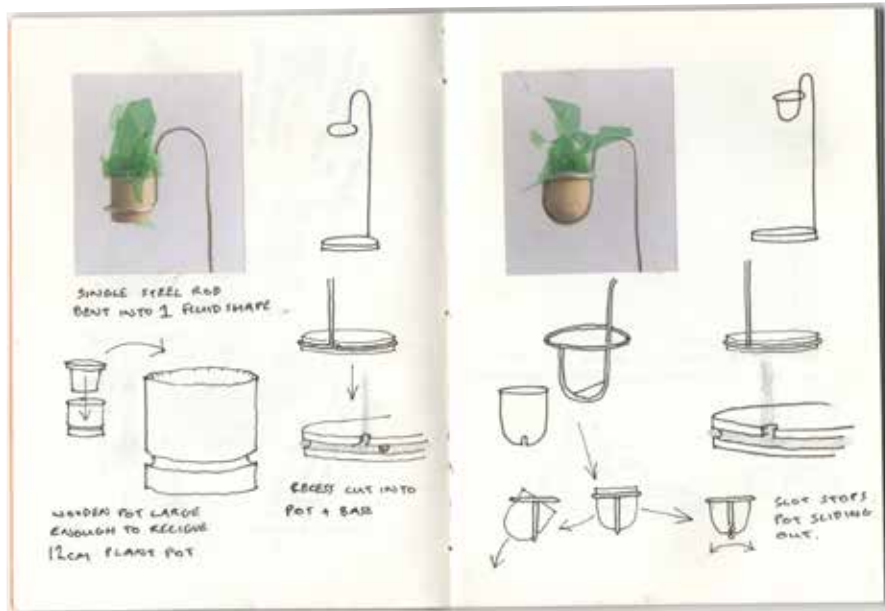

Sketches, Model Making & CAD Drawings



both /

Exterior Pipe Detailing
2018

19
20



Handheld Product Research

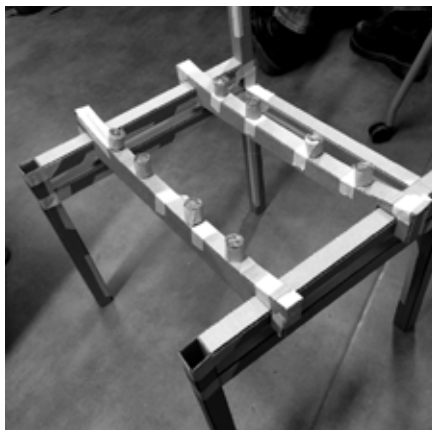
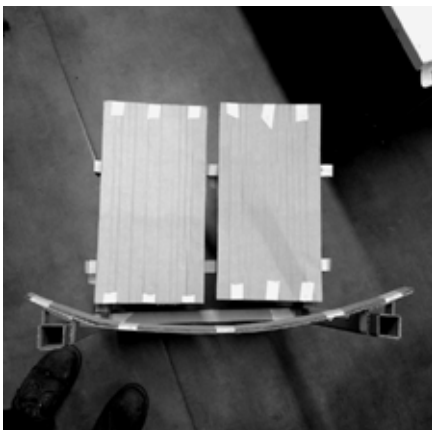

Furniture Prototyping

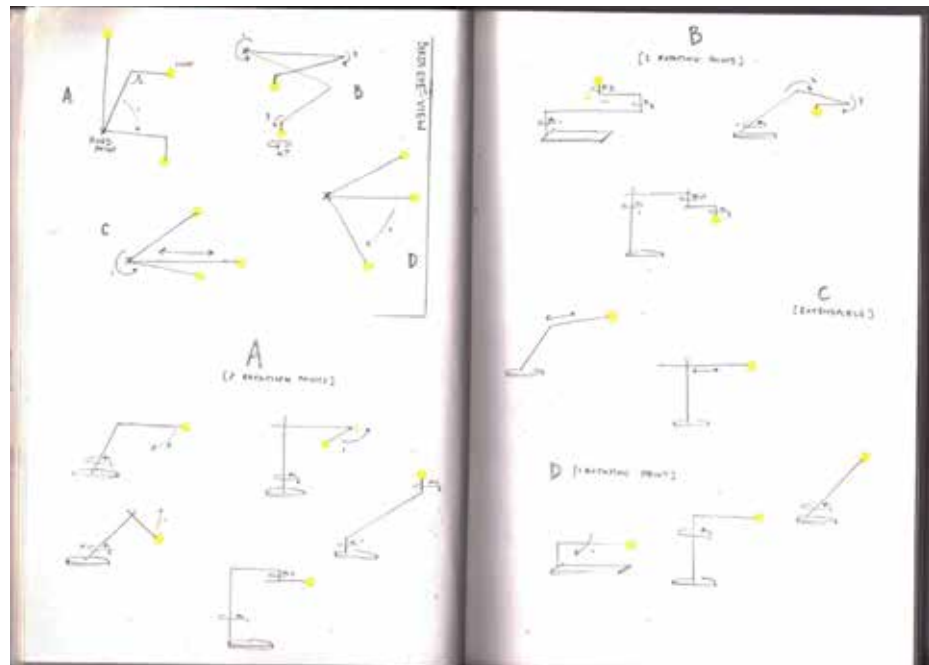
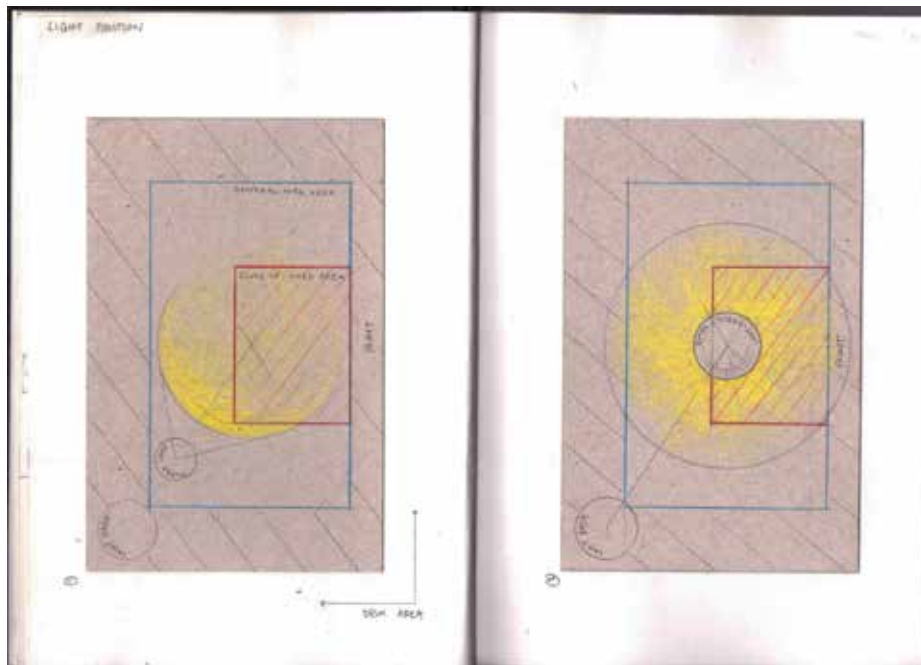
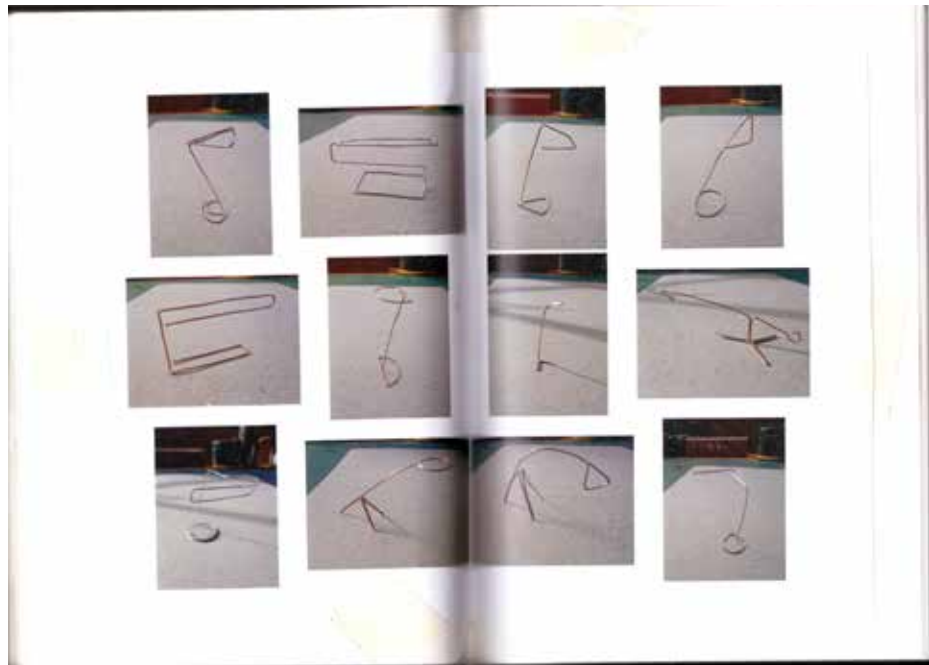
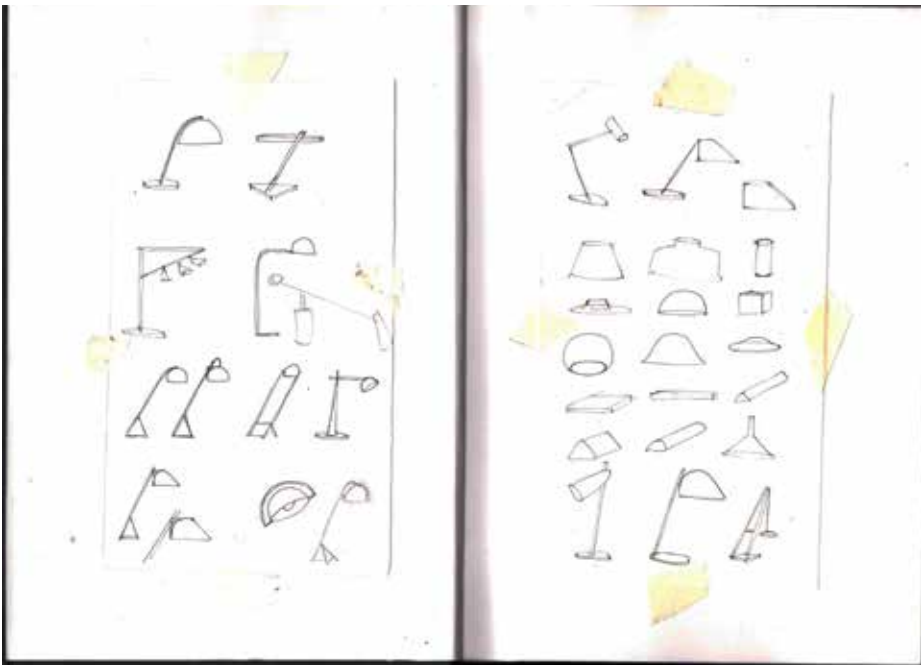

Task Lamp Development (continued overleaf...)

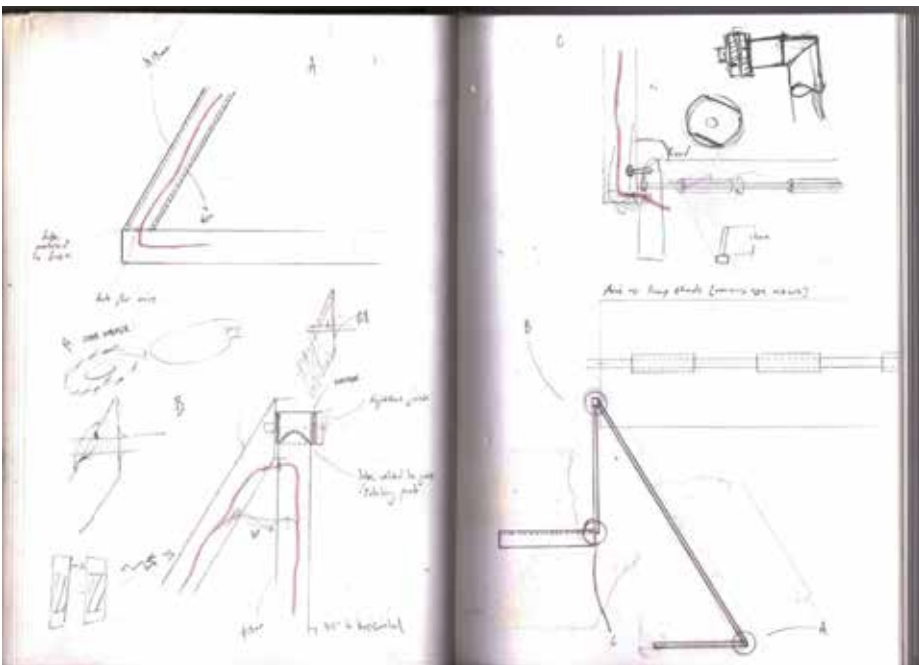
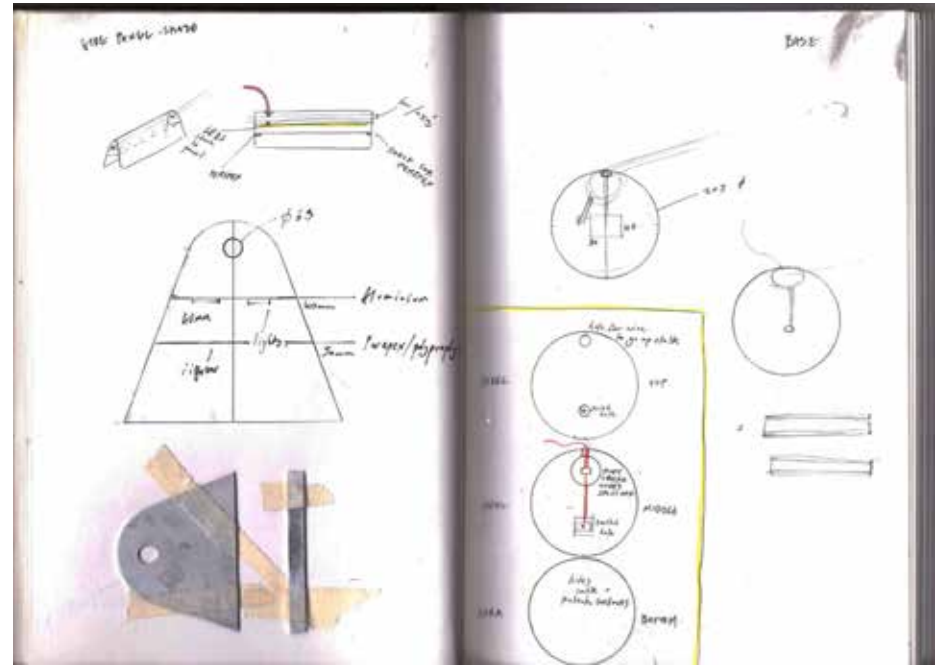
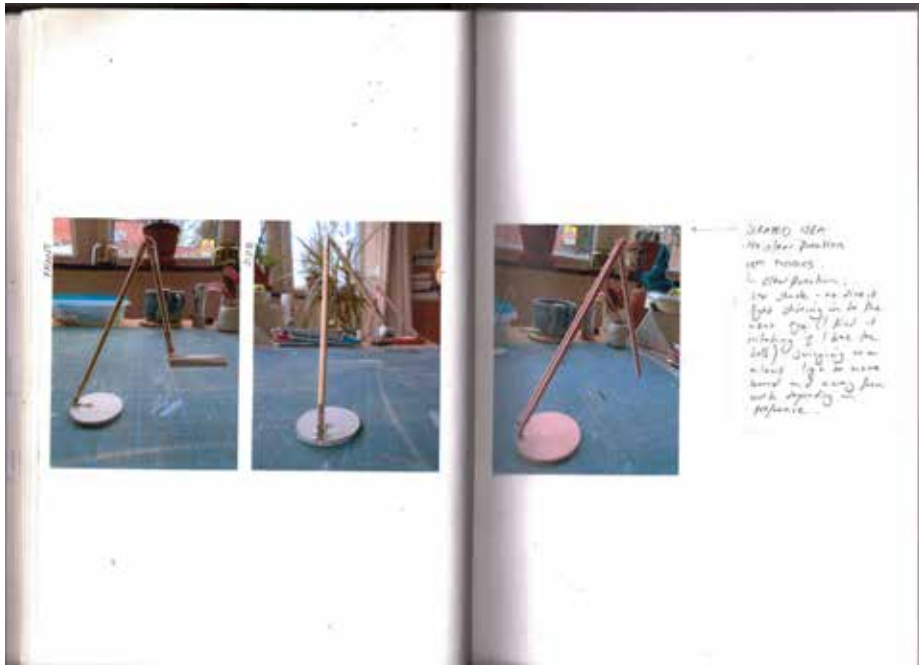

Task Lamp Development (continued)

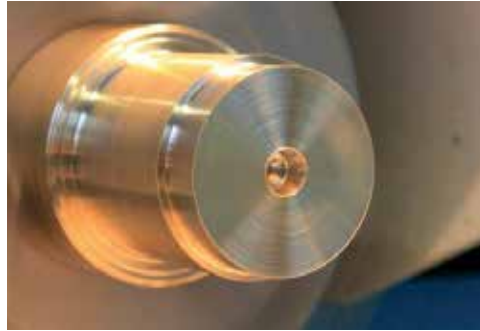

Manufacturing Process